

edesa

DECORATIVE CHIMNEY-STYLE



ECP-6411 X

Cod. 932271891

EAN 8435436108730

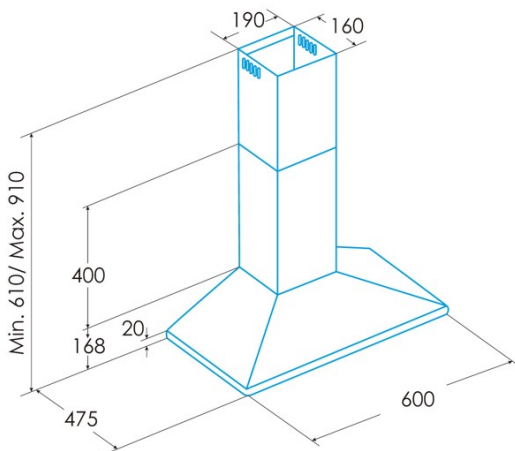

GENERAL INFORMATION

EAN/UPC	8435436108730
Subfamily	Chimney

Product sheet according to directives EU65/2014 - EN61591, EN60704-2-13, EN50564

AEC (Annual energy consumption) (kWh/year)	53,7
EEL class (energy efficiency class)	C
FDE (fluid dynamic efficiency)	10,3
FDE class (fluid dynamic efficiency class)	E
LE (light efficiency) (lux/W)	8,4
LE class (light efficiency class)	E
GFE (grease filtering efficiency)	71,4
GFE class (grease filtering efficiency class)	D
Airflow in normal mode MIN (m3/h)	210
Airflow in normal mode MAX (m3/h)	420
Acoustic power in normal mode MIN (dB)	53
Acoustic power in normal mode MAX (dB)	65
Po (energy consumption in off mode) (W)	0
Ps (energy consumption in standby mode) (W)	0

Integration directive EU 66/2014

f (time increase factor)	1,6
EEL (Energy Efficiency Index)	84,4
QBEP (maximum efficiency at air flow point) (m3/h)	220
PBEP (maximum efficiency at pressure point) (Pa)	130
WBEP (power consumption at maximum efficiency) (W)	76,9
WL (nominal power lighting system) (W)	11
EMIDDLE (Average illuminance on the cooking surface) (lux)	92,5

External Dimensions

Width (mm)	600
Depth (mm)	475
Maximum total height (mm)	910
Minimum total height (mm)	610
Diamètre de sortie (mm)	150, 125

Characteristics

Motor quantity	1
Motor model	K7PLUS
Maximum pressure (Pa)	200
Filter technology	Aluminium mesh
Control technology	Mechanical push button
Booster	-
Power levels	3
Timer	-
Filter saturation indicator	-
Charcoal filter replacement indicator	-
Dimmer function	-
Connectivity	-
Remote control	-
Display	-

Lighting

Light model	LED E-14
Ray technology	LED

Installation

Minimum distance to electric plate (mm)	650
Minimum distance to gas plate (mm)	650
Recirculation option	√
Charcoal filter	-
Back draught shutter	Included
Inner shield	-

Electric connection

Nominal voltage (V)	220-240
Nominal frequency (Hz)	50/60

Nominal input power (W)	106
Electric shock protection	Class II
Power cord length (m)	1,5

Accessories

Upper decorative duct extension	2862302
White decorative duct	No
Black decorative duct	No
Island tube booster	No
Back draught shutter	Included
MAX PRO Metal filter	2800917
Activated charcoal filter	2859394
Noiseless flexible duct	2893002
Recirculation kit	No
